

Lavado alta presión

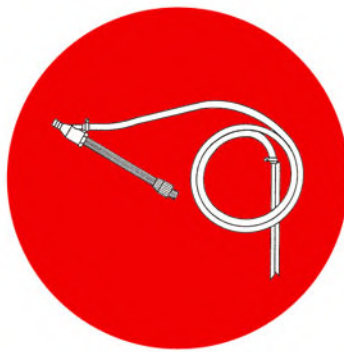

C/Riumors, 7 - 17600 Figueres
Tel.972 50 45 25 - 972 50 04 80 Fax 972 67 11 51
info@imafigueres.com - www.imafigueres.com



RECAMBIOS MAQUINAS LAVAR

PRESION MAXIMA 210 BAR
CAUDAL MAXIMO: 25 L/M.
TEMPERATURA MAXIMA: 150 °C

Descarga agua en reposo, evitando la formación de hielo

PISTOLA AURA ANTIHIELO

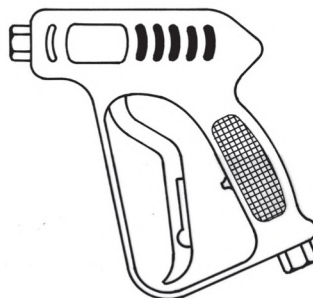

CODIGO

415.331

ROSCA ENTRADA

3/8" GAS HEMBRA

ROSCA SALIDA

1/4" GAS HEMBRA

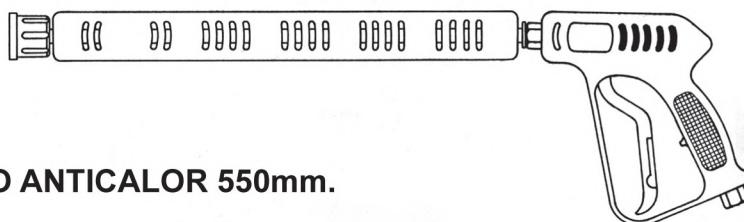

CON ALARGO ANTICALOR 550mm.

PISTOLA ASTRA 320 MT2

PRESION MAXIMA: 320 BAR
CAUDAL MAXIMO: 40 L/M.
TEMPERATURA MAXIMA: 150 °C

CODIGO

415.334

TUBO

INOX

ROSCA ENTRADA

3/8" GAS HEMBRA

ROSCA SALIDA

1/2" GAS T. GIRAT.

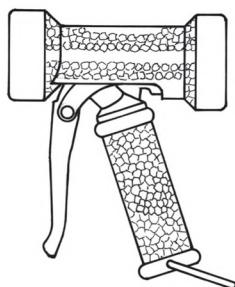

PISTOLA PULVERIZADORA DE AGUA

PRESION MAXIMA: 24 BAR
CAUDAL MAXIMO 100 L/M.

CODIGO

415.354

LARGO

140 mm.

ROSCA ENTRADA

1/2" GAS HEMBRA



RECAMBIOS MAQUINAS LAVAR

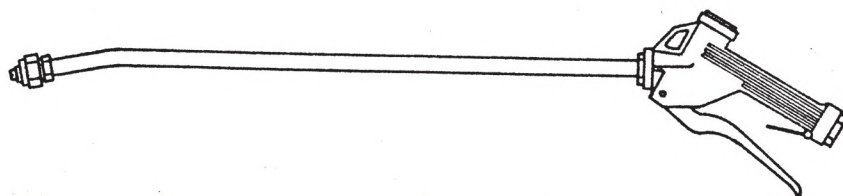

PISTOLA PULVERIZADORA AGUA

PRESION MAXIMA: 25 BAR
CAUDAL MAXIMO: 70 L/M.

CODIGO	TUBO	LARGO	ROSCA ENTRADA
415.352	ZINCADO	600 mm.	1/4" GAS HEMBRA

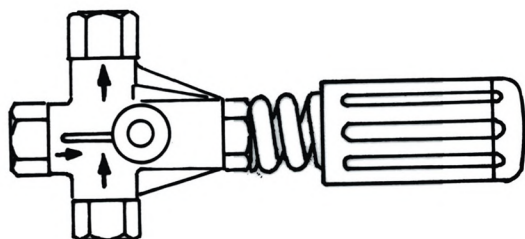

TEMPERATURA MAXIMA: 90 °C.
MATERIAL: LATON

VALVULA LIMITADORA PRESION BY-PASS MG-4000

CODIGO	PRESION TRABAJO	ROSCAS ENTRADA-SALIDA	ROSCA BY-PASS
415.319	120 BAR	3/8" GAS	1/4" GAS
415.320	280 BAR	3/8" GAS	1/4" GAS

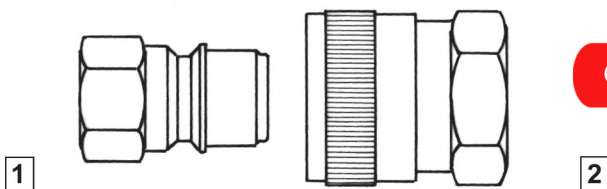

CONEXION RAPIDA LATON

PRESION TRABAJO: 200 BAR

	CODIGO	DESCRIPCION	ROSCA	MATERIAL
1	415.323	MACHO	3/8" GAS	INOX
	415.325	MACHO	3/8" GAS	ACERO
2	415.327	HEMBRA	3/8" GAS	LATON



RECAMBIOS MAQUINAS LAVAR

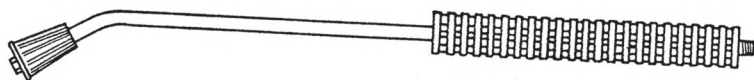

LANZA ANTICALOR SIMPLE MT3

PRESION MAXIMA: 320 BAR
CAUDAL MAXIMO: 40 L/M.
TEMPERATURA MAXIMA: 150 °C

CODIGO	TUBO	LARGO	ROSCA ENTRADA
415.335	ZINCADO	700 mm.	1/4" GAS MACHO
415.337	ZINCADO	1.200 mm.	1/4" GAS MACHO
415.338	ZINCADO	1.700 mm.	1/4" GAS MACHO
415.339	INOX	700 mm	1/4" GAS MACHO
415.341	INOX	1.200 mm.	1/4" GAS MACHO
415.343	INOX	1.700 mm.	1/4" GAS MACHO

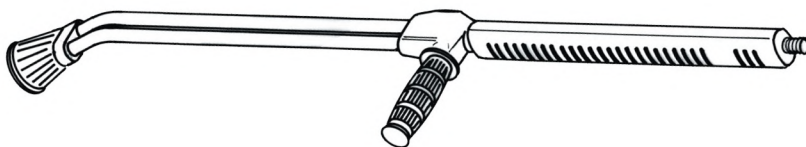

LANZA ANTICALOR DOBLE MT2

PRESION MAXIMA: 320 BAR
CAUDAL MAXIMO: 40 L/M.
TEMPERATURA MAXIMA: 150 °C

CODIGO	TUBO	LARGO	ROSCA ENTRADA
415.345	ZINCADO	1.035 mm.	1/4" GAS MACHO
415.350	INOX	1.035 mm.	1/4" GAS MACHO

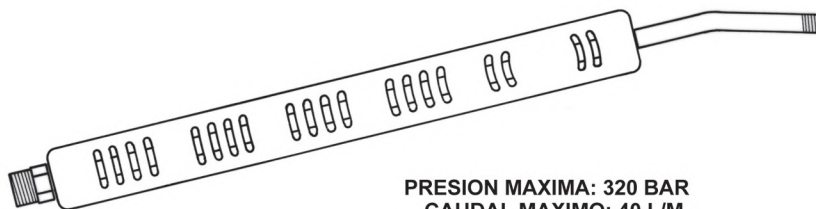

PRESION MAXIMA: 320 BAR
CAUDAL MAXIMO: 40 L/M.
TEMPERATURA MAXIMA: 150 °C

LANZA ANTICALOR SIMPLE-PROTECCION TOTAL

CODIGO	TUBO	LARGO	ROSCA ENTRADA
415.348	INOX	550 mm.	1/2" GAS MACHO
415.349	INOX	800 mm.	1/2" GAS MACHO



RECAMBIOS MAQUINAS LAVAR

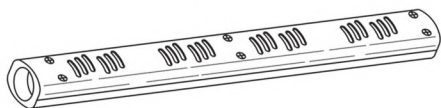

PROTECTOR TERMICO LANZA

CODIGO	LARGO	Φ INTERIOR
415.648	380 mm.	13,6



ALARGADERA CEPILLOS INOX

CODIGO	TUBO	LARGO	ROSCA ENTRADA
415.640	INOX	1.200 mm.	1/4" GAS

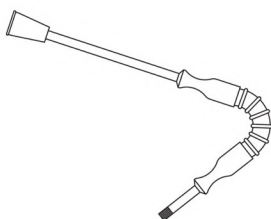

LANZA ANTICALOR SIMPLE FLEXIBLE

PRESION MAXIMA: 175 BAR
CAUDAL MAXIMO: 30 L/M.
TEMPERATURA MAXIMA: 90 °C

CODIGO	TUBO	LARGO	ROSCA ENTRADA
415.397	INOX	600 mm.	1/4" GAS MACHO

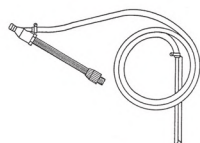

PROLONGACION CHORRO DE ARENA

PRESION MAXIMA: 150 BAR

CODIGO	MANGUERA	ROSCA ENTRADA
415.353	3 metros	1/4" GAS



RECAMBIOS MAQUINAS LAVAR

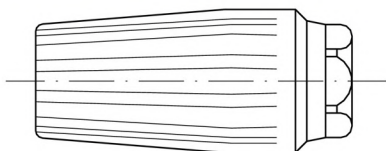

CABEZA BOQUILLA "TURBO"

CODIGO	ROSCA ENTRADA	PRESION MAX.
415.315	1/4" GAS HEMBRA	160 BAR
415.317	1/4" GAS HEMBRA	210 BAR

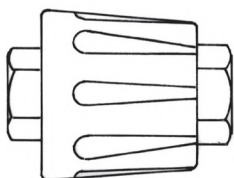

CABEZA REGULADORA PRESION

PRESION MAXIMA: 250 BAR
TEMPERATURA MAXIMA 150 °C

CODIGO	ROSCA ENTRADA	ROSCA SALIDA
415.355	1/4" GAS HEMBRA	1/4" GAS HEMBRA

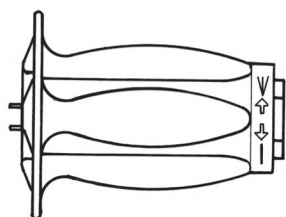

PRESION MAXIMA: 175 BAR
CAUDAL MAXIMO: 30 L/M.
TEMPERATURA MAXIMA: 90 °C

CABEZA "VAPJET" VAPORIADORA DE ANGULO

CODIGO	TUBO	LARGO	ROSCA ENTRADA
415.397	INOX	600 mm.	1/4" GAS MACHO



RECAMBIOS MAQUINAS LAVAR

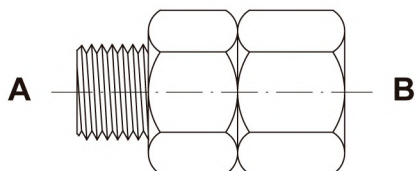

RACOR GIRATORIO INOX

PRESION TRABAJO: 310 BAR
CAUDAL MAXIMO: 30 LITROS/
MINUTO

CODIGO	MATERIAL	ROSCA A	ROSCA B
415.502	INOXIDABLE	3/8" GAS MACHO	3/8" GAS HEMBRA
415.492	LATON	3/8" GAS MACHO	3/8" GAS HEMBRA

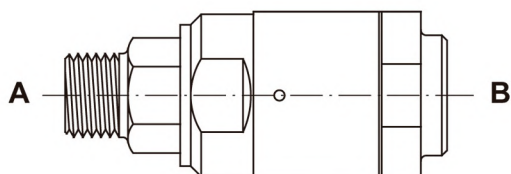

PRESION TRABAJO: 350 BAR
CAUDAL MAXIMO: 40 LITROS/MINUTO

RACOR GIRATORIO LATON

CODIGO	ROSCA A	ROSCA B
415.522	3/8" GAS MACHO	3/8" GAS HEMBRA

RACOR GIRATORIO INOX

PRESION TRABAJO: 280 BAR
CAUDAL MAXIMO: 40 LITROS/MINUTO

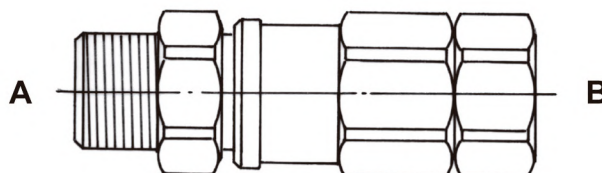

CODIGO	ROSCA A	ROSCA B
416.320	3/8" GAS MACHO	1/4" GAS HEMBRA
416.322	3/8" GAS MACHO	3/8" GAS HEMBRA
416.321	3/8" GAS HEMBRA	1/4" GAS HEMBRA



RECAMBIOS MAQUINAS LAVAR

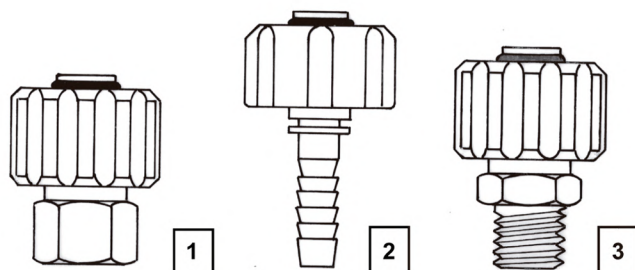

MATERIAL:

1	ANTITERMICO-LATON
2	ANTITERMICO-HIERRO
3	ANTITERMICO-LATON

RACORES CONEXION ANTICALOR

	CODIGO	ROSCA	ACOPLE
1	227.01.01	TUERCA 22/150	HEMBRA 1/4" GAS
	227.03.03	TUERCA 22/150	HEMBRA 3/8" GAS
2	227.04.04	TUERCA 22/150	TUBO R-2 1/4"
	227.05.05	TUERCA 22/150	TUBO R-2 5/16"
	227.06.06	TUERCA 22/150	TUBO R-2 3/8"
3	227.08.04	TUERCA 22/150	MACHO 1/4" GAS
	227.08.06	TUERCA 22/150	MACHO 3/8" GAS

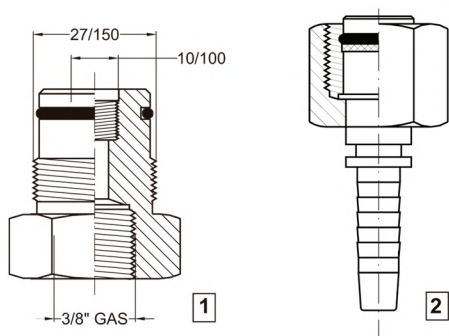

RACORES ESPECIAL WAP - ALTO

MATERIAL: 1 LATON
2 TUERCA LATON - NIPEL INOX - ESPIGA ITALIANA

	CODIGO	ROSCA	ACOPLE
1	226.01.10	TUERCA 3/8" GAS - 10/100	MACHO 27/150
2	227.01.08	TUERCA 21/150	TUBO R2 5/16"



RECAMBIOS MAQUINAS LAVAR

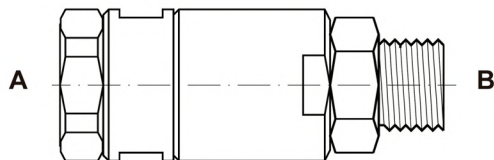

RACOR GIRATORIO INOX - EXTRA

280 BAR 40 LITROS/MINUTO

CODIGO	ROSCA A	ROSCA B
416.330	1/4" GAS HEMBRA	1/4" GAS MACHO
416.331	3/8" GAS HEMBRA	3/8" GAS MACHO

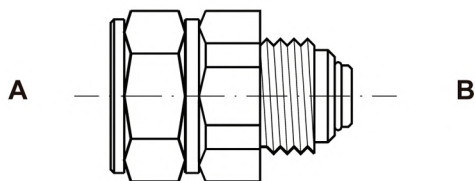

RACOR GIRATORIO RECTO LATON

280 BAR 30 LITROS/MINUTO

CODIGO	ROSCA A	ROSCA B
415.296	3/8" GAS MACHO	3/8" GAS HEMBRA

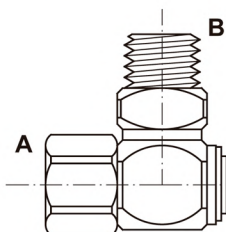

280 BAR 30 LITROS/MINUTO

RACOR GIRATORIO CODO 90°C LATON

CODIGO	ROSCA A	ROSCA B
415.300	1/2" GAS MACHO	1/2" GAS HEMBRA



RECAMBIOS MAQUINAS LAVAR

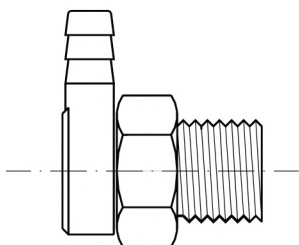

VALVULA PROTECCION TERMICA

CODIGO	ROSCA	SALIDA	TEMPERATURA
415.465	1/4" GAS	D. 7 mm.	63 °C/145 °F

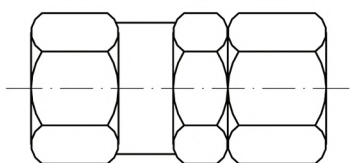

VALVULA ANTIRETORNO ALTA PRESION LATON

CODIGO	ROSCA	PRESION MAX.
415.470	1/4" GAS HEMBRA	310 BAR
415.471	3/8" GAS HEMBRA	310 BAR
415.472	1/2" GAS HEMBRA	210 BAR

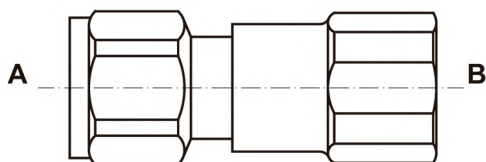

RACOR GIRATORIO LATON

280 BAR 40 LITROS/MINUTO

CODIGO	ROSCA A	ROSCA B
416.370	3/8" GAS HEMBRA	1/4" GAS HEMBRA
416.371	3/8" GAS HEMBRA	3/8" GAS HEMBRA



RECAMBIOS MAQUINAS LAVAR

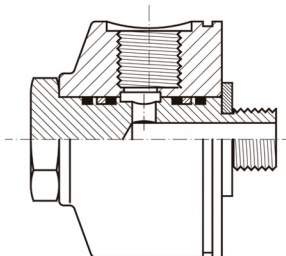

RACOR GIRATORIO INOX. 90º

PRESION TRABAJO: 310 BAR
CAUDAL MAXIMO: 30 LITROS/MINUTO

CODIGO	ROSCA A	ROSCA B
416.334	1/4" GAS MACHO	1/4" GAS HEMBRA
416.335	3/8" GAS MACHO	3/8" GAS HEMBRA

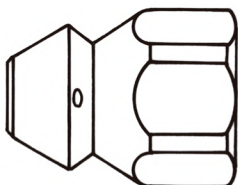

BOQUILLA LIMPIEZA CLOACA INOX

CODIGO	ROSCA HEMBRA	TALADROS SALIDA
416.318	1/4" GAS HEMBRA	3 + 1 (D. 1mm.)
416.319	1/4" GAS HEMBRA	3 + 1 (D. 1,2 mm.)

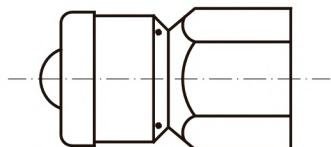

280 BAR 40 LITROS/MINUTO

BOQUILLA GIRATORIA LIMPIEZA CLOACA

CODIGO	ROSCA HEMBRA	TALADROS SALIDA
415.541	1/4" GAS HEMBRA	3 X 0,8
415.542	3/8" GAS HEMBRA	3 X 1,2



RECAMBIOS MAQUINAS LAVAR

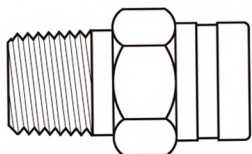

BOQUILLA INOX LANZA 1/8" GAS ANGULO 25°

CODIGO	MATERIAL	PRESION EN BARS			MEDIDA	ANGULO
		100 (caudales en litros/minuto)	150	200		
416.404	INOX	6,8	8,3	9,6	03/25	25°
416.405	INOX	7,8	9,6	11	03,5/25	25°
416.406	INOX	9,2	11,2	13	04/25	25°
416.407	INOX	10,2	12,5	14,4	04,5/25	25°
416.408	INOX	11,4	14	16	05/25	25°
416.409	INOX	12,5	15,3	17,7	05,5/25	25°
416.410	INOX	13,8	17	19,5	06/25	25°

BOQUILLA INOX.LANZA 1/8" GAS ANGULO 0°

CODIGO	MATERIAL	PRESION EN BARS			MEDIDA	ANGULO
		100 (caudales en litros/minuto)	150	200		
416.484	INOX	6,8	8,3	9,6	03/0	0°
416.485	INOX	9,2	11,2	13	04/0	0°
416.487	INOX	11,4	14	16	05/0	0°
416.489	INOX	13,8	17	19,5	06/0	0°
416.491	INOX	16	20	22,5	07/0	0°

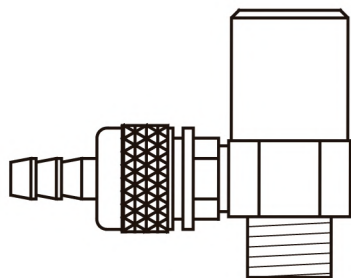

APORTADOR DE DETERGENTE REGULABLE

CODIGO

416.293

ROSCA ENTRADA

HEMBRA 3/8" GAS

ROSCA DE SALIDA

MACHO 3/8" GAS



RECAMBIOS MAQUINAS LAVAR

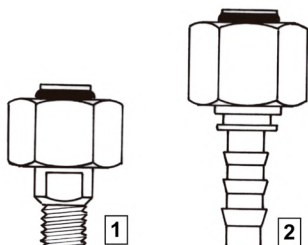

RACORES CONEXION

- 1 TUERCA HIERRO - ESPIGA LATON
2 HIERRO ZINCADO

	CODIGO	ACOPLE	MANGUERA
1	224.01.01	TUERCA 22/150	MACHO 1/4" GAS
	226.01.04	TUERCA 22/150	TUBO R-2 1/4"
2	226.01.05	TUERCA 22/150	TUBO R-2 5/16"
	226.01.06	TUERCA 22/150	TUBO R-2 3/8"

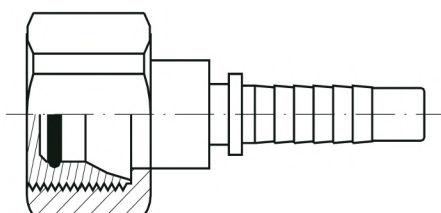

RACORES CONEXION STANDARD

MATERIAL: INOXIDABLE

CODIGO	ROSCA	ACOPLE
226.01.04X	TUERCA 22/150	TUBO R-2 1/4"
226.01.05X	TUERCA 22/150	TUBO R-2 5/16"
226.01.06X	TUERCA 22/150	TUBO R-2 3/8"

RACORES CONEXION STANDARD

MATERIAL: LATON

CODIGO	ROSCA	ACOPLE
226.01.04-L	TUERCA 22/150	TUBO R-2 1/4"
226.01.05-L	TUERCA 22/150	TUBO R-2 5/16"
226.01.06-L	TUERCA 22/150	TUBO R-2 3/8"



RECAMBIOS MAQUINAS LAVAR

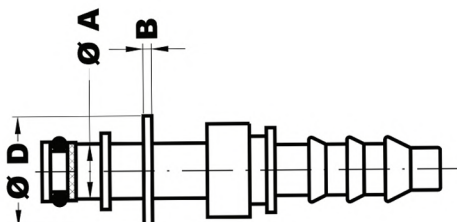

RACORES KARCHER STANDAR

HIERRO ZINCADO - CABEZA 10mm.

CODIGO	CABEZA (A)	ARANDELA		ACOPLE
		B	D	
226.04.04	KARCHER A=10 mm	3 mm	21 mm	TUBO R-2 1/4"
226.05.05	KARCHER A=10 mm	3 mm	21 mm	TUBO R-2 5/16"
226.06.06	KARCHER A=10 mm	3 mm	21 mm	TUBO R-2 3/8"

RACORES KARCHER STANDARD

INOXIDABLE - CABEZA 10mm.

CODIGO	CABEZA (A)	ARANDELA		ACOPLE
		B	D	
226.04.04-X	KARCHER A=10 mm	3 mm	21 mm	TUBO R-2 1/4"
226.05.05-X	KARCHER A=10 mm	3 mm	21 mm	TUBO R-2 5/16"
226.06.06-X	KARCHER A=10 mm	3 mm	21 mm	TUBO R-2 3/8"

RACORES KARCHER ESPECIAL

INOXIDABLE - CABEZA 11mm.

CODIGO	CABEZA (A)	ARANDELA		ACOPLE
		B	D	
226.14.04-X	KARCHER A=11 mm	6 mm	22 mm	TUBO R-2 1/4"
226.15.05-X	KARCHER A=11 mm	6 mm	22 mm	TUBO R-2 5/16"
226.12.06-X	KARCHER A=11 mm	6 mm	22 mm	TUBO R-2 3/8"



RECAMBIOS MAQUINAS LAVAR

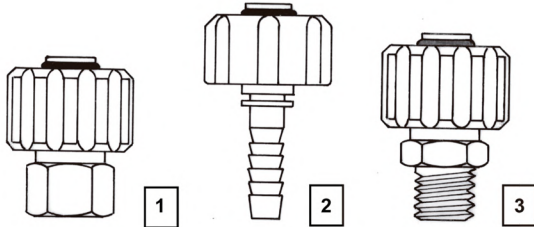

MATERIAL:

1	ANTITERMICO-LATON
2	ANTITERMICO-HIERRO
3	ANTITERMICO-LATON

RACORES CONEXION ANTICALOR

	CODIGO	ROSCA	ACOPLE
1	227.01.01 227.03.03	TUERCA 22/150 TUERCA 22/150	HEMBRA 1/4" GAS HEMBRA 3/8" GAS
2	227.04.04 227.05.05 227.06.06	TUERCA 22/150 TUERCA 22/150 TUERCA 22/150	TUBO R-2 1/4" TUBO R-2 5/16" TUBO R-2 3/8"
3	227.08.04 227.08.06	TUERCA 22/150 TUERCA 22/150	MACHO 1/4" GAS MACHO 3/8" GAS

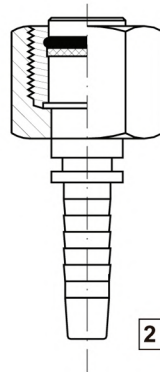
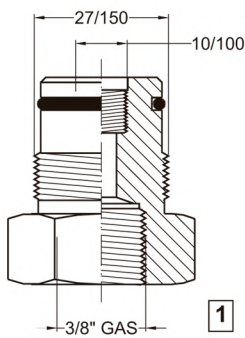

RACORES ESPECIALES WAP - ALTO

MATERIAL: 1 LATON
2 TUERCA LATON - NIPEL INOX - ESPIGA ITALIANA

	CODIGO	ROSCA	ACOPLE
1	226.01.10	TUERCA 3/8" GAS - 10/100	MACHO 27/150
2	227.01.08	TUERCA 21/150	TUBO R2 5/16"



RECAMBIOS MAQUINAS LAVAR

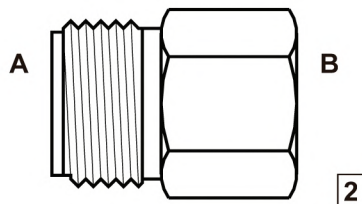
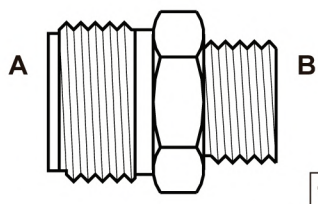

UNION DOBLE LATON

	CODIGO	ROSCA A	ROSCA B
1	415.305	M.22/150	1/4" GAS (macho)
	415.307	M.22/150	3/8" GAS (macho)
	415.309	M.22/150	M.22/150 (macho)
2	415.313	M.22/150	1/4" GAS (hembra)
	415.314	M.22/150	3/8" GAS (hembra)

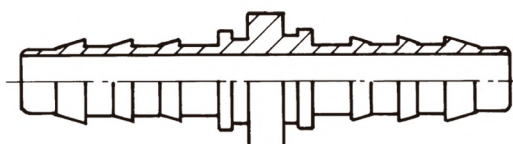

MATERIAL: HIERRO ZINCADO

RACORES REPARAR PARA TUBO ALTA PRESION SAE 100R-2

CODIGO	MANGUERA	MANGUERA
224.04.04	TUBO R-2 1/4"	TUBO R-2 1/4"
224.05.05	TUBO R-2 5/16"	TUBO R-2 5/16"
224.06.06	TUBO R-2 3/8"	TUBO R-2 3/8"

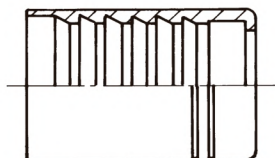

CASQUILLOS RACOR ALTA PRESION SAE 100 R-2

MATERIAL: HIERRO ZINCADO

CODIGO	MANGUERA
220.00.04	TUBO R-2 1/4"
220.00.05	TUBO R-2 5/16"
220.00.06	TUBO R-2 3/8"



RECAMBIOS MAQUINAS LAVAR

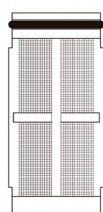
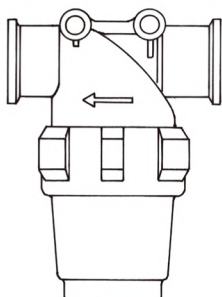

FILTRO AGUA EN LINEA (POLIPROPILENO)

CODIGO

ROSCAS

415.360	3/4" GAS HEMBRA
415.362	1" GAS HEMBRA
415.364	CARTUCHO RECAMBIO PLASTICO/INOX. (100 M)

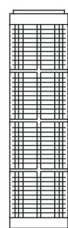
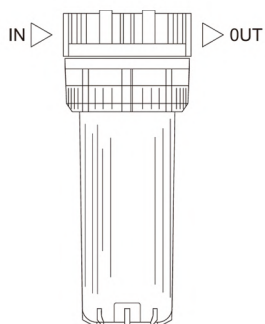

FILTRO AGUA EN LINEA POLICARBONATO (SIN CARTUCHO)

CODIGO

ROSCAS

415.445	3/4" GAS HEMBRA
415.446	1" GAS HEMBRA

CARTUCHO FILTRANTE

CODIGO

MATERIAL

MICRAS

415.448	PLASTICO	80
415.449	INOXIDABLE	80



RECAMBIOS MAQUINAS LAVAR



FILTRO AGUA EN LINEA (POLIPROPILENO)

CODIGO	Φ TUBO	COLOR
228.04.04	1/4" - 17 mm	NEGRO
228.05.05	5/16" - 19 mm	NEGRO
228.06.06	3/8" - 21 mm	NEGRO
229.05.05	5/16" - 19 mm	AZUL
229.06.06	3/8" - 21 mm	AZUL



CAMBIADOR PRESION POR BOLA

CODIGO	ROSCA ENTRADA	ROSCA SALIDAS
415.561	1/4" GAS HEMBRA	2 x 1/4" GAS HEMBRA

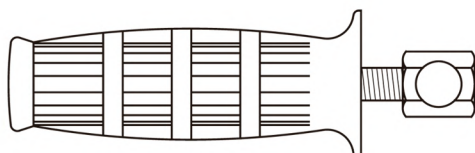

MANGO LANZA CON FIJACION

CODIGO	ROSCA	Φ TUBO
415.650	M.10/100	13,6



RECAMBIOS MAQUINAS LAVAR

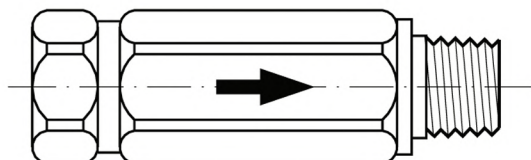

FILTRO LINEA ALTA PRESION

PRESION MAXIMA 350 BAR

CODIGO	ROSCAS	MICRAS
415.280	1/4" GAS	280

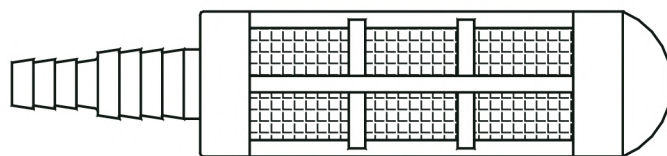

FILTRO ASPIRACION FONDOS LATON MALLA INOX

CODIGO	MANGUERA	VALVULA
415.910	15mm Y 21mm	SIN VALVULA
415.912	15mm Y 21mm	CON VALVULA

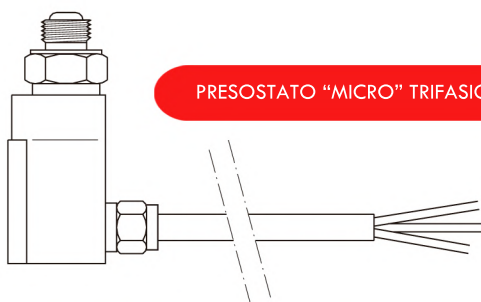

PRESOSTATO "MICRO" TRIFASICO

PRESION MAX. 280 BAR
TEMPERATURA MAX. 90°C
MAX. 250 V.
MAX. 5 A.

CODIGO	ROSCA	BAR
378.040	1/4" GAS	15
378.041	1/4" GAS	25
378.042	1/4" GAS	40



RECAMBIOS MAQUINAS LAVAR



GIRO 360°
PRESION MAX. 210 BAR
TEMPERATURA MAX. 120°

BRAZO GIRATORIO INOX CON 1 MUELLE CON CONEXION A TUBO

CODIGO

415.485

ROSCAS

1/4" GAS

LARGO

1.550 mm.

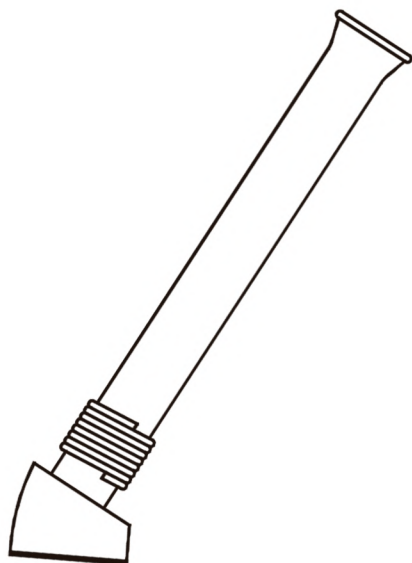

PORTALANZAS FLEXIBLE INOX FIJACION EN EL PAVIMENTO

CODIGO

415.645

LARGO

650 mm.



RECAMBIOS MAQUINAS LAVAR



PRESION: 400 BAR
TEMPERATURA: 160°

ENROLLADOR AUTOMATICO TUBO ALTA PRESION INOX - CERRADO

CODIGO	TUBO	ROSCA
601.505	15 Metros	3/8" GAS
601.508	SIN TUBO	3/8" GAS



PRESION: 400 BAR
TEMPERATURA: 160°

ENROLLADOR AUTOMATICO TUBO ALTA PRESION INOX - ABIERTO

CODIGO	TUBO	ROSCA
601.509	SIN TUBO	3/8" GAS